

3-inch Fixed Dome Junction Box

TR-JB03-IN



Specifications

Bracket	TR-JB03-IN
Application	Wall installation for IPC32 Series fixed dome
Dimensions	Φ109mmx36mm (4.3" x1.4")
Weight	0.16kg(0.35lb)
Material	Aluminum alloy

Dimensions

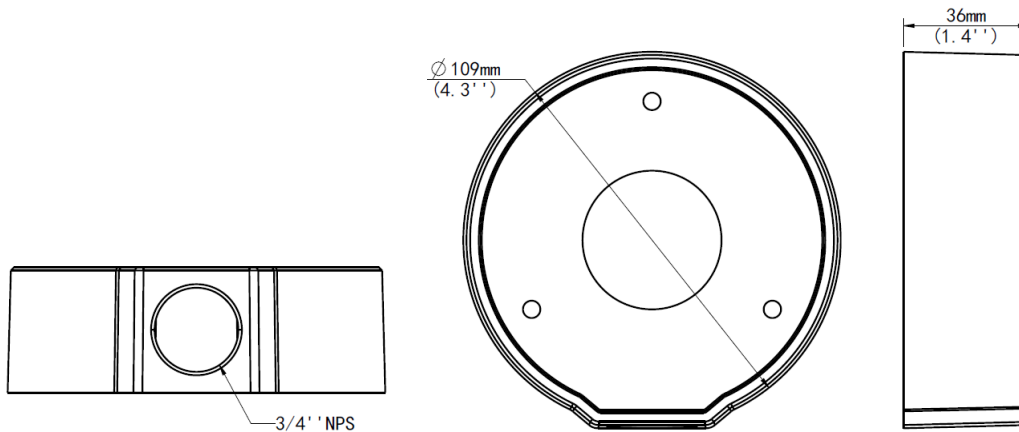

Zhejiang Uniview Technologies Co.,Ltd.

South Tower, Building 10, Wanlun Science Park, 88 Jiangling Road, Hangzhou, P.R.China 310051

Email: overseasbusiness@uniview.com; globalsupport@uniview.com

<http://www.uniview.com>

©2015 Zhejiang Uniview Technologies Co.,Ltd. All rights reserved.

*Product specifications and availability are subject to change without notice.